

**CITY OF DANA POINT
PLANNING COMMISSION
AGENDA REPORT**

DATE: MAY 31, 2018

TO: DANA POINT PLANNING COMMISSION

FROM: COMMUNITY DEVELOPMENT DEPARTMENT
URSULA LUNA-REYNOSA, DIRECTOR
SEAN NICHOLAS, SENIOR PLANNER

SUBJECT: SIGN PROGRAM PERMIT SPP18-0002 FOR UNION BANK
LOCATED AT 24532 DEL PRADO (LIGHTHOUSE BUILDING)

RECOMMENDATION: That the Planning Commission adopt the attached draft Resolution approving Sign Program Permit SPP18-0002 for Union Bank located at 24532 Del Prado (Lighthouse Building)

OWNER: Muller-Lighthouse, LLC (Stephen and Brandon Muller)

APPLICANTS AGENT: Mike Arteaga, Coast Signs

REQUEST: Approval of a new Sign Program for the new Union Bank location at 24532 Del Prado.

LOCATION: 24532 Del Prado (APN: 682-191-03)

NOTICE: Pursuant to Section 9.26.010(f) related to projects within the Town Center Mixed Use District of the Dana Point Zoning Code (DPZC).

ENVIRONMENTAL: Pursuant to the California Environmental Quality Act (CEQA), the project is categorically exempt per Section 15301 of the CEQA Guidelines (Class 1 – Existing Facilities) in that the project consists of a minor alteration of an existing structure.

ISSUES:

1. Is the proposal consistent with the Dana Point General Plan, Town Center, and Dana Point Zoning Code?
2. Is the proposed project compatible and an enhancement to the site and surrounding neighborhood?

BACKGROUND:

The subject site is located on the south side of Del Prado between Violet Lantern and Amber Lantern within the City's Town Center Mixed-Use Plan area. The site is bounded by other commercial uses to the west, east, and across Del Prado, and residential to the south. The site contains an existing multi-story building with two tenants and a parking lot accessed from the alley behind the building.

The proposed Sign Program proposes two primary signs, one facing Del Prado and one facing the alley, and four signs providing site identification and directions. The commercial building has no signs onsite, and the other tenant, the property owners, do not intend to have a sign. The proposed sign program promotes a cohesive design while enhancing the visibility of the new primary tenant.

Section 9.37.060 of the City's Zoning Code requires approval of a Sign Program for any new or upgraded multi-tenant center which proposes two (2) or more signs on a site. The applicant is proposing six (6) signs in total.

DISCUSSION:

Due to the change in primary tenant for the building, a sign program is required as six signs are proposed. If approved, the Sign Program will provide regulations and guidelines for all new signs onsite.

The purpose and intent of a Sign Program is to integrate signs with the building design into a unified architectural statement. Components of the Sign Program subject to review include: design, placement, size, and to ensure compliance with Section 9.37.150 (Permitted Signs) of the DPZC.

Proposed Signs: The Applicant is proposing the following signs for this center:

- Tenant Identification Wall Signs (2 total; sheets 3, 4, 8, & 9): The primary tenant identification signs will be 17 square feet, and be sand blasted wood. The material and style of the sign will match the design of the Lighthouse Building. The illumination of the signs will be through exterior decorative goose neck lighting, conditioned to be approved by the Director of Community Development prior to issuance of Administrative Sign Permits to ensure aesthetic compatibility.
- Hanging Signs (2 total, sheets 5, 6, & 10): A 6.48 square foot hanging sandblasted wood sign is proposed on both sides of the building to provide pedestrian and automobile scale signs for people traveling on Del Prado. The architectural design is similar in material and style to the primary tenant identification signs and compatible with the building architecture. These signs are not illuminated.

- Directional Signs (2 total, sheets 5, 7, 11, & 12): One of the two directional signs is located on the north face of the building facing the parking lot of 24522 Del Prado. The second directional sign is a 48 inch tall pole sign located in the alley with an arrow indicating the entrance to the parking area.

Compliance with the Sign Ordinance: The tenant identification signs meet the area limitations of Section 9.37.150(d) of the Sign Ordinance, which allows one square foot of sign area for each lineal foot of building frontage along a public right-of-way or parking lot. Since the 55.76 square feet of proposed sign area is less than the eligible lineal building frontage totaling 146 feet, the Sign Program complies with the maximum area allowed for the building.

CONCLUSION:

Staff finds that the proposed Sign Program would provide a visually attractive and consistent sign design with the overall building architecture. In accordance with the City's Sign Guidelines, the Sign Program includes placement of wall signs where architectural features or details suggest a location and would facilitate tenant identification throughout the property. The signage would constitute an enhancement to the existing building and overall site improvements, while providing signage opportunities for the primary tenant within the Town Center. Staff accordingly supports the proposed Sign Program and recommends approval of SPP 18-0002, subject to conditions contained in the attached, draft resolution.

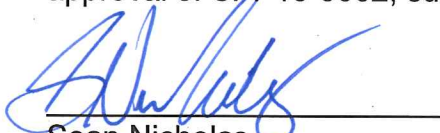
Sean Nicholas
Senior Planner

Ursula Luna-Reynosa, Director
Community Development Department

ACTION DOCUMENTS:

1. Draft PC Resolution 18-05-31-XX

SUPPORTING DOCUMENTS

2. Sign Program for Union Bank at the "Lighthouse" Building

RESOLUTION NO. 18-05-31-XX

A RESOLUTION OF THE PLANNING COMMISSION OF THE CITY OF DANA POINT, CALIFORNIA, APPROVING SIGN PROGRAM SPP18-0002 FOR A COMMERCIAL BUILDING LOCATED AT 24532 DEL PRADO

The Planning Commission for the City of Dana Point does hereby resolve as follows:

WHEREAS, Mike Arteaga, Coast Signs, (the "Applicant") is the representative of real property commonly referred to as 24532 Del Prado (APN 682-191-03) (the "Property"); and

WHEREAS, the Applicant has made an application to establish a new Sign Program (attached as exhibit A to this resolution) for a multi-tenant commercial building located at 24532 Del Prado; and

WHEREAS, said verified application constitutes a request as provided by Title 9 of the Dana Point Municipal Code; and

WHEREAS, pursuant to the California Environmental Quality Act (CEQA), the project is Categorically Exempt per Sections 15301 (e) (Class 1 – Existing Facilities) of the CEQA Guidelines in that the project proposes minor exterior improvements to an existing commercial center; and

WHEREAS, the Planning Commission did, on the 31st day of May, 2018, reviewed the Sign Program as prescribed by law; and

WHEREAS, at said Planning Commission Review, upon considering all testimony and arguments, if any, of all persons desiring to be heard, said Commission considered all factors relating to Sign Program SPP18-0002.

NOW, THEREFORE, BE IT HEREBY RESOLVED by the Planning Commission of the City of Dana Point as follows:

- A) The above recitations are true and correct and incorporated herein by reference.
- B) Based on the evidence presented, the Planning Commission adopts the following findings and approves Sign Program SPP18-0002, subject to conditions:

Findings:

1. That the design, placement, size, and content of the proposed signage is compatible with the project architecture **in that the signs utilized to identify the primary use of the site, Union Bank, are all sand blasted wood signs which match the materials and design characteristics of the “Lighthouse” building.**
2. That the Sign Program is in substantial compliance with the Permitted Sign Types detailed in the City of Dana Point Zoning Code **in that the signs are compliant with all allowed sign types, and the proposed sign area is less than the total allowed sign area. The overall design of the proposal is consistent with the style of the building.**

Conditions:

A. General:

1. Approval of this application permits the establishment of a Sign Program located at 24532 Del Prado. Subsequent submittals for this project shall be in substantial compliance with the sign plans approved by the Planning Commission, and in compliance with the applicable provisions of the Dana Point General Plan/Local Coastal Program, Dana Point Town Center Plan and the Dana Point Zoning Code.
2. The application is approved as a plan for the location and design of the uses, structures, features, and materials, shown on the approved plans. Any relocation, alteration, or addition to any use, structure, feature, or material, not specifically approved by this application, will nullify this approving action. If any changes are proposed regarding the location or alteration to the appearance or use of any structure, an amendment to this permit shall be submitted for approval by the Director of Community Development. If the Director of Community Development determines that the proposed change complies with the provisions and the spirit and intent of this approval action, and that the action would have been the same for the amendment as for the approved plot plan, he may approve the amendment without requiring a new public hearing.
3. Approval of this application shall be valid for a period of 24 months

from the date of determination. If the scope-of-work approved by this action is not established, or a building permit for the project is not issued within such period of time, the approval shall expire and shall thereafter be null and void.

4. Failure to abide by and faithfully comply with any and all conditions attached to the granting of this permit shall constitute grounds for revocation of said permit.
5. The Applicant or any successor-in-interest shall defend, indemnify, and hold harmless the City of Dana Point ("CITY"), its agents, officers, or employees from any claim, action, or proceeding against the CITY, its agents, officers, or employees to attack, set aside, void, or annul an approval or any other action of the CITY, its advisory agencies, appeal boards, or legislative body concerning the project. Applicant's duty to defend, indemnify and hold harmless the city shall include paying the CITY's attorney fees, costs and expenses incurred concerning the claim, action or proceeding.

The Applicant or any successor-in-interest shall further protect, defend, indemnify and hold harmless the City, its officers, employees, and agents from any and all claims, actions or proceedings against the City, its officers, employees, or agents arising out of or resulting from negligence of the Applicant or the Applicant's agents, employees or contractors. Applicant's duty to defend, indemnify and hold harmless the City shall include paying the CITY's attorney fees, costs and expenses incurred concerning the claim, action, or proceeding.

The Applicant shall also reimburse the City for City Attorney fees and costs associated with the review of the proposed project and any other related documentation.

- 6) The Applicant and Applicant's successors in interest shall be fully responsible for knowing and complying with all conditions of approval, including making known the conditions to City staff for future governmental permits or actions on the project site.
- 7) The Applicant and Applicant's successors in interest shall be responsible for payment of all applicable fees along with reimbursement for all City expense in ensuring compliance with these conditions.
- 8) The Applicant and individual tenants shall obtain separate permits

for installation of individual tenant or center identification signs.

B. Prior to the issuance of a building and sign permit, the Applicant shall meet the following conditions:

- 9) The Applicant shall submit three (3) sets of plans to the Planning Division that will review the permit with input from the Building Division for plan check so that Planning and Building approval and permits can be issued concurrently once plan check review is completed. Plans shall be submitted on sheets no smaller than 11" x 17".
- 10) Improvements shall comply with the most recently adopted local and State building code regulations, which may include the CBC, CMC, CPC and CEC with State amendments for disabled accessibility and energy conservation, and all other recently adopted code regulations that may apply.

C. Prior to final building permit release, the Applicant shall meet the following conditions:

- 11) After installation, Applicant shall obtain final approval from the Planning Division prior to Building Permit final inspection.

PASSED, APPROVED, AND ADOPTED at a regular meeting of the Planning Commission of the City of Dana Point, California, held on this 31st day of May 2018, by the following vote, to wit:

AYES:

NOES:

ABSENT:

ABSTAIN:

Scott McKhann, Chairman
Planning Commission

ATTEST:

Ursula Luna-Reynosa, Director
Community Development Department

DRAFT

SITE PLAN

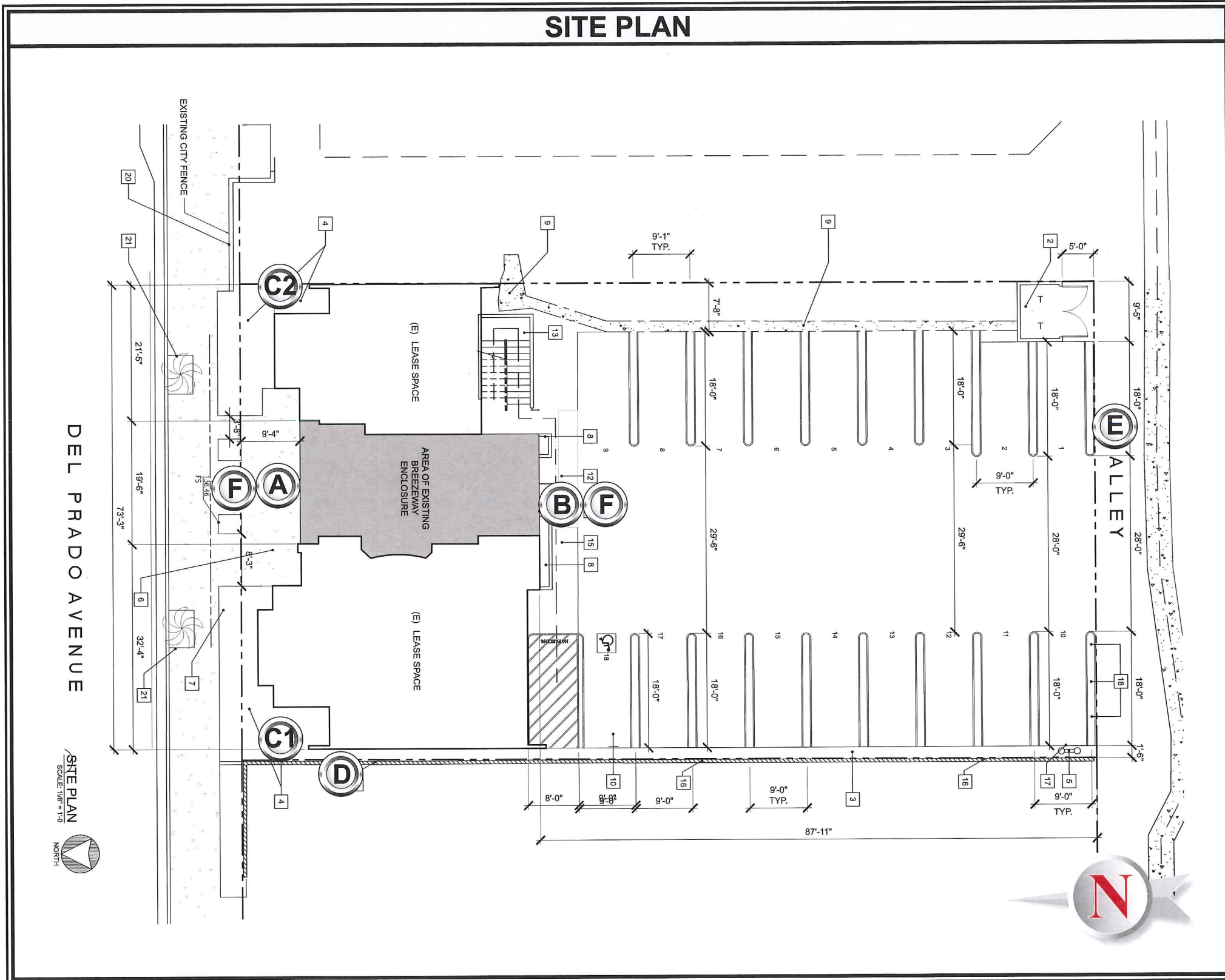

SIGNAGE SPECIFICATIONS

- (A)** S/F SAND BLASTED HANGING SIGN
Manufacture and Install (1) Hanging Sign
- (B)** S/F SAND BLASTED WALL SIGN
Manufacture and Install (1) Sand Blasted Wall Sign
- (C1)** S/F HANGING SAND BLASTED WALL SIGN
Manufacture and Install (1) Sand Blasted Wall Sign
- (C2)** S/F HANGING SAND BLASTED WALL SIGN
Manufacture and Install (1) Sand Blasted Wall Sign
- (D)** WALL MOUNTED PLAQUE
Manufacture and Install (1) Wall Plaque Sign.
- (E)** DIRECTIONAL SIGN
Manufacture and Install (1) Directional Sign
- (F)** GOOSE NECK LIGHTING FIXTURE
Customer to provide Goose Neck Lighting Fixture

AREA MAP

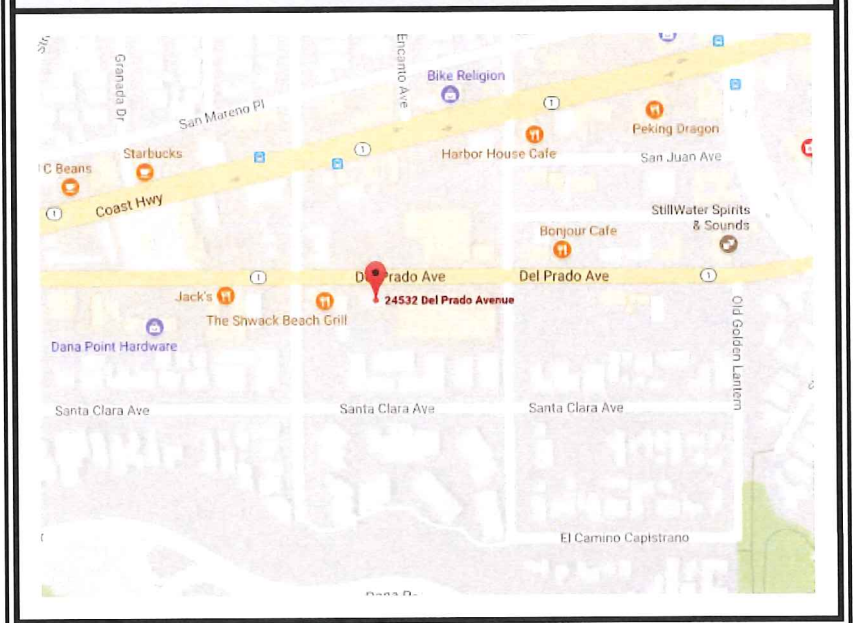

DEL PRADO AVENUE

SITE PLAN
SCALE: 1/8" = 1'-0"
NORTH

COAST SIGN
INCORPORATED
1500 West Embassy St. Anaheim, CA 92802
(714) 520-9144 FAX: (714) 520-5847

Date:	08-02-17	Project Name:	UNION BANK
Scale:	NTS	Address:	24532 Del Prado Ave
Drawn:	Nariel L.	City / State / Zip:	Dana Point, CA 92629
Sales:	Derrick N.	Client Approval:	Date:

This is an original unpublished drawing created by Coast Sign, Inc. It is submitted for your personal use in conjunction with a project being planned for you by Coast Sign, Inc., And shall not be reproduced, used by or disclosed to any firm or corporation for any purpose whatsoever without written permission.

No.	Designer	Date	Revision Notes	No.	Designer	Date	Revision Notes
1	WA	8-14-17	refer to PATHFINDER.	7	John A.	09-29-17	refer to PATHFINDER.
2	JV	08-24-17	Added Signs C (monument sign)	8	Charles C.	12-20-17	Refer to PATHFINDER for details.
3	WA	08-30-17	refer to PATHFINDER.	9	Nariel L.	01-18-18	Refer to PATHFINDER for details.
4	WA	09-01-17	refer to PATHFINDER.	10	Rodel B.	02-07-18	Refer to PATHFINDER for details.
5	WA	09-05-17	refer to PATHFINDER.	11	John A.	02-27-18	Refer to PATHFINDER for details.
6	John A.	09-27-17	refer to PATHFINDER.	12			

DESIGN DRAWING 1 of 13

Request Number:
DEV-UBOC-00094-R12
W:\Union Bank\Art\Drawings\DEV-UBOC-00094

SQUARE FOOTAGE TABLE FOR EVERY SIGN

SIGN A - S/F SAND BLASTED HANGING SIGN	17.04 SQ.FT
SIGN B - S/F SAND BLASTED HANGING SIGN	17.04 SQ.FT
SIGN C1 - S/F HANGING SAND BLASTED WALL SIGN	6.48 SQ.FT
SIGN C2 - S/F HANGING SAND BLASTED WALL SIGN	6.48 SQ.FT
SIGN D - WALL MOUNTED PLAQUE	6.25 SQ.FT
SIGN E - DIRECTIONAL SIGN	2.44 SQ.FT
TOTAL SQUARE FOOTAGE:	55.76 SQ.FT



Date: 08-02-17	Project Name: UNION BANK
Scale:	Address: 24532 Del Prado Ave
Drawn: Nariel L.	City / State / Zip: Dana Point, CA 92629
Sales: Derrick N.	Client Approval: _____ Date: _____

This is an original unpublished drawing created by Coast Sign, Inc. It is submitted for your personal use in conjunction with a project being planned for you by Coast Sign, Inc., And shall not be reproduced, used by or disclosed to any firm or corporation for any purpose whatsoever without written permission.

No.	Designer	Date	Revision Notes	No.	Designer	Date	Revision Notes
1	WA	8-14-17	refer to PATHFINDER.	7	John A.	09-29-17	refer to PATHFINDER.
2	JV	08-24-17	Added Signs C (monument sign)	8	Charle C.	12-20-17	Refer to PATHFINDER for details.
3	WA	08-30-17	refer to PATHFINDER.	9	Nariel L.	01-18-18	Refer to PATHFINDER for details.
4	WA	09-01-17	refer to PATHFINDER.	10	Rodel B.	02-07-18	Refer to PATHFINDER for details.
5	WA	09-05-17	refer to PATHFINDER.	11	John A.	02-27-18	Refer to PATHFINDER for details.
6	John A.	09-27-17	refer to PATHFINDER.	12			

DESIGN DRAWING 2 of 13
Request Number: DEV-UBOC-00094-R12
W:\Union Bank\Art\Drawings\DEV-UBOC-00094

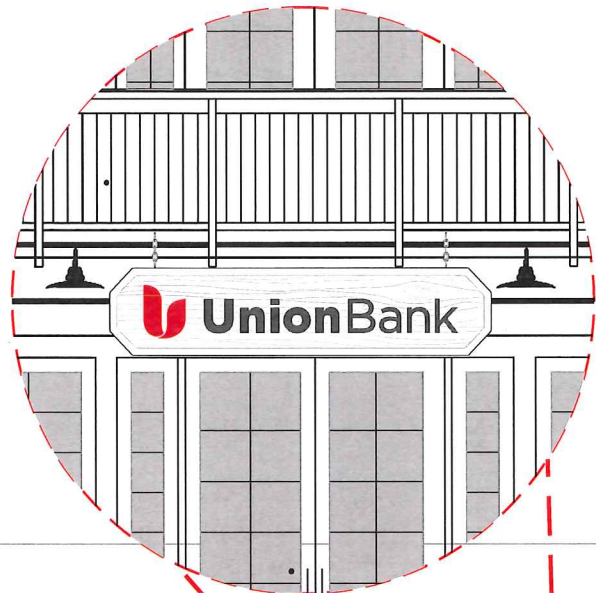

BLOW UP VIEW

Scale: NTS

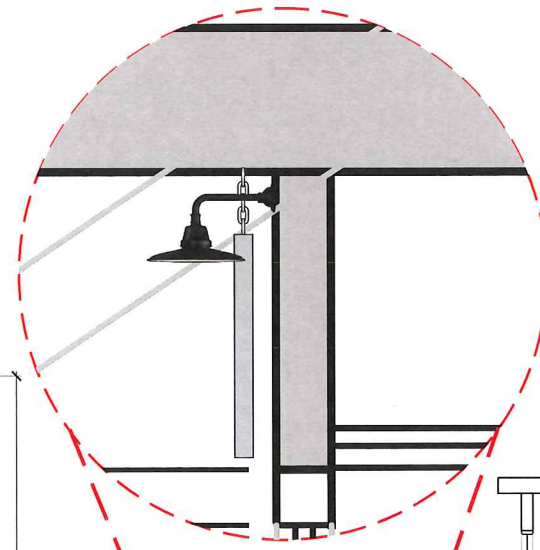

BLOW UP VIEW

Scale: NTS

Note: Union Bank to confirm Specific Gooseneck specs /type. Customer to verify exact placement of Gooseneck lighting, and Sign A can be placed under the balcony close to Gooseneck lighting as desired"

"Customer to provide Gooseneck Lighting"

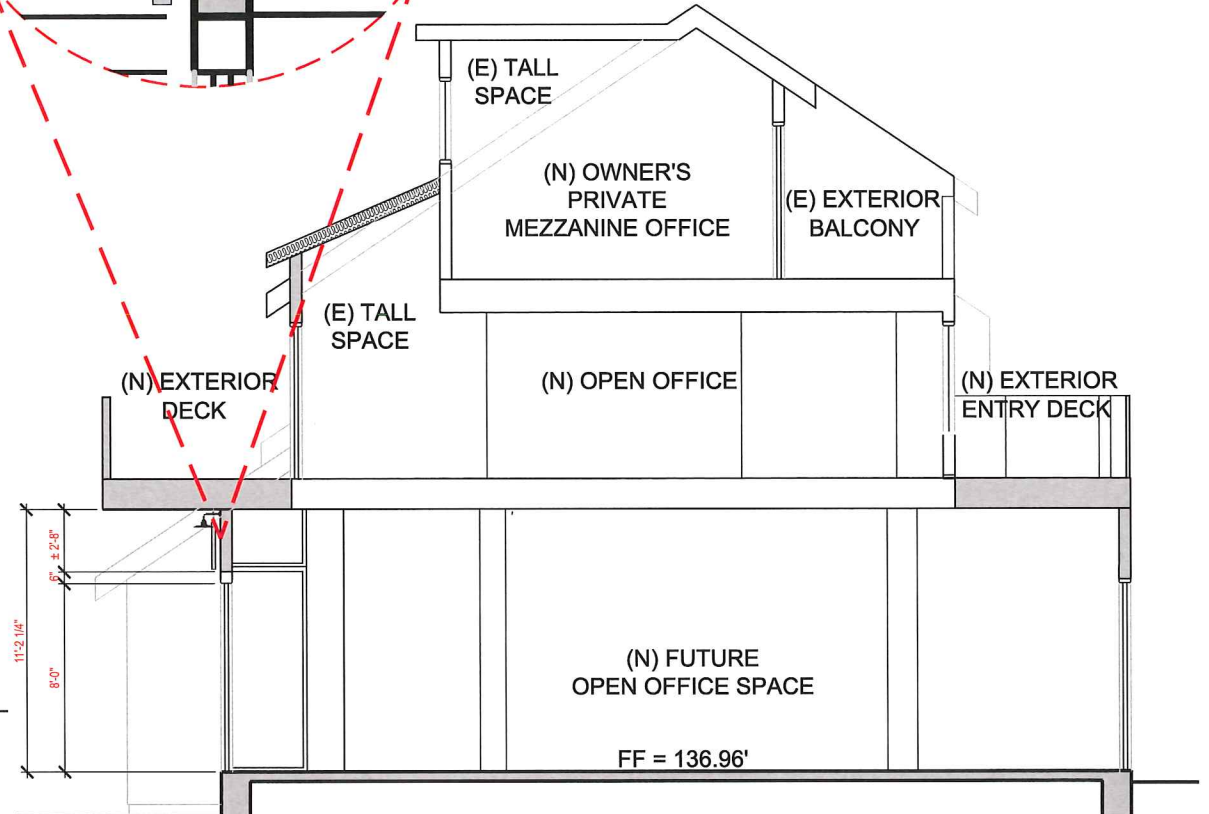
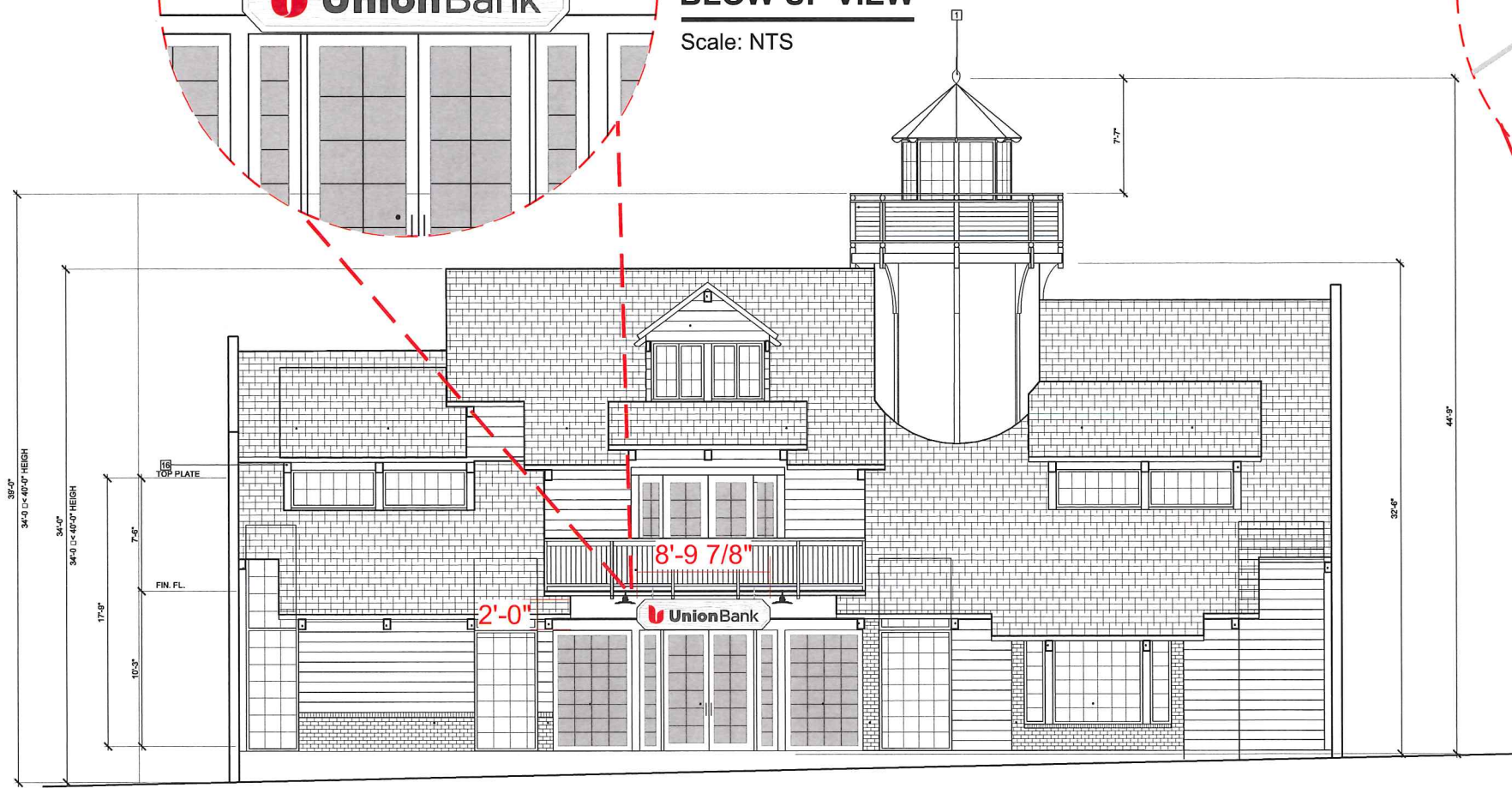

SECTION A DETAIL

Scale: 1/8" = 1'-0"



NORTH ELEVATION @ SAND BLASTED HANGING SIGN

Scale: 1/16" = 1'-0"

**NOTE: CONCEPTUAL IMAGE ONLY
VERIFY ARTWORK AND DIMENSIONS
PRIOR TO FABRICATION**



Date:	08-02-17	Project Name:	UNION BANK
Scale:	AS NOTED	Address:	24532 Del Prado Ave
Drawn:	Nariel L.	City / State / Zip:	Dana Point, CA 92629
Sales:	Derrick N.	Client Approval:	Date:

This is an original unpublished drawing created by Coast Sign, Inc. It is submitted for your personal use in conjunction with a project being planned for you by Coast Sign, Inc., And shall not be reproduced, used by or disclosed to any firm or corporation for any purpose whatsoever without written permission.

No.	Designer	Date	Revision Notes	No.	Designer	Date	Revision Notes
1	WA	8-14-17	refer to PATHFINDER.	7	John A.	09-29-17	refer to PATHFINDER.
2	JV	08-24-17	Added Signs C (monument sign)	8	Charle C.	12-20-17	Refer to PATHFINDER for details.
3	WA	08-30-17	refer to PATHFINDER.	9	Nariel L.	01-18-18	Refer to PATHFINDER for details.
4	WA	09-01-17	refer to PATHFINDER.	10	Rodel B.	02-07-18	Refer to PATHFINDER for details.
5	WA	09-05-17	refer to PATHFINDER.	11	John A.	02-27-18	Refer to PATHFINDER for details.
6	John A.	09-27-17	refer to PATHFINDER.	12			

DESIGN DRAWING 3 of 13
Request Number:
DEV-UBOC-00094-R12
W:\Union Bank\Art\Drawings\DEV-UBOC-00094

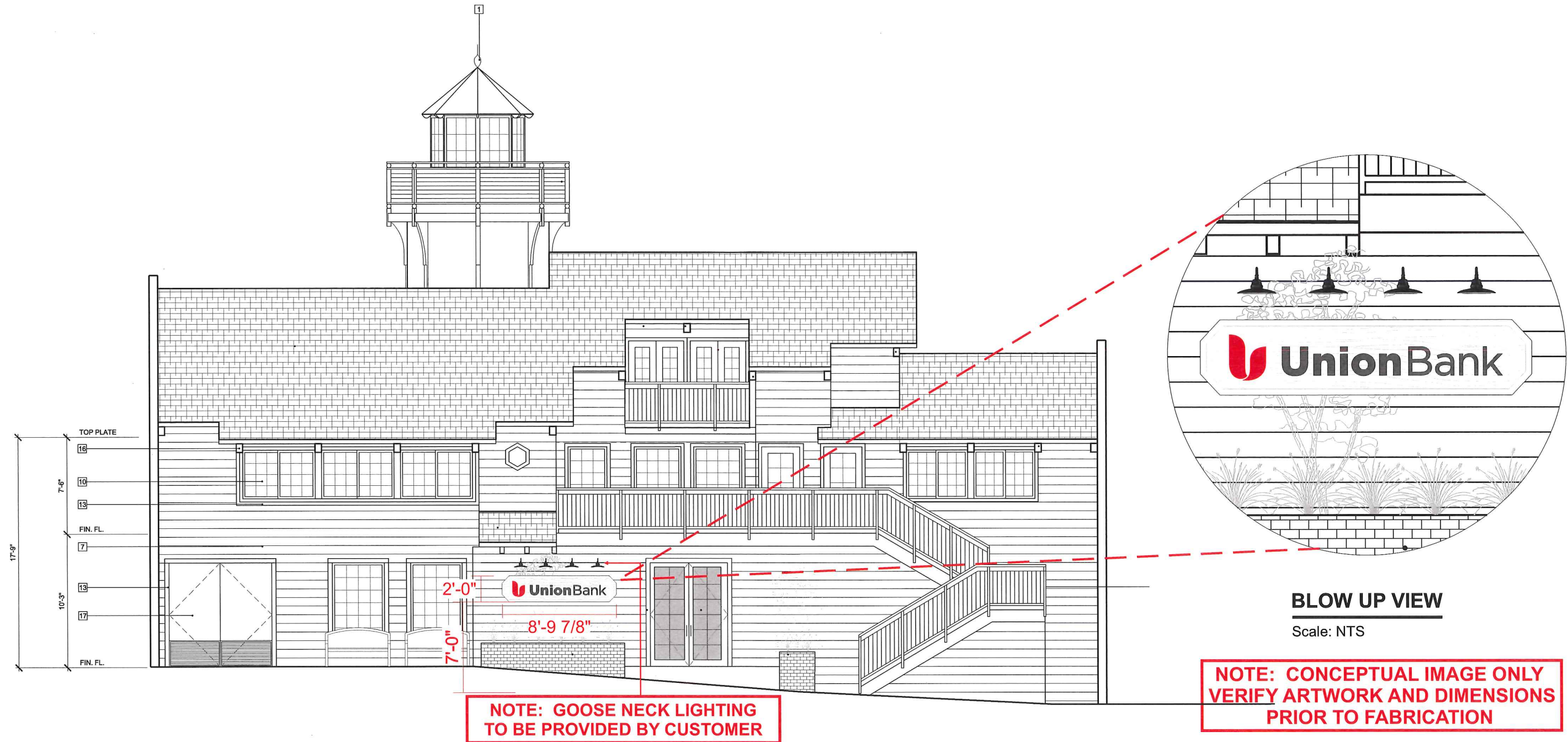

B F SOUTH ELEVATION @ SAND BLASTED SIGN
Scale: 1/8"=1'-0"



Date: 08-02-17	Project Name: UNION BANK
Scale: AS NOTED	Address: 24532 Del Prado Ave
Drawn: Nariel L.	City / State / Zip: Dana Point, CA 92629
Sales: Derrick N.	Client Approval: _____ Date: _____

This is an original unpublished drawing created by Coast Sign, Inc. It is submitted for your personal use in conjunction with a project being planned for you by Coast Sign, Inc., And shall not be reproduced, used by or disclosed to any firm or corporation for any purpose whatsoever without written permission.

No.	Designer	Date	Revision Notes	No.	Designer	Date	Revision Notes
1	WA	8-14-17	refer to PATHFINDER.	7	John A.	09-29-17	refer to PATHFINDER.
2	JV	08-24-17	Added Signs C (monument sign)	8	Charle C.	12-20-17	Refer to PATHFINDER for details.
3	WA	08-30-17	refer to PATHFINDER.	9	Nariel L.	01-18-18	Refer to PATHFINDER for details.
4	WA	09-01-17	refer to PATHFINDER.	10	Rodel B.	02-07-18	Refer to PATHFINDER for details.
5	WA	09-05-17	refer to PATHFINDER.	11	John A.	02-27-18	Refer to PATHFINDER for details.
6	John A.	09-27-17	refer to PATHFINDER.	12			

DESIGN DRAWING 4 of 13
Request Number:
DEV-UBOC-00094-R12
W:\Union Bank\Art\Drawings\DEV-UBOC-00094

EXISTING PHOTO- SIGN C1, D



PHOTO ENHANCEMENT- SIGN C1, D



Date:	08-02-17	Project Name:	UNION BANK
Scale:		Address:	24532 Del Prado Ave
Drawn:	Nariel L.	City / State / Zip:	Dana Point, CA 92629
Sales:	Derrick N.	Client Approval:	Date:

This is an original unpublished drawing created by Coast Sign, Inc. It is submitted for your personal use in conjunction with a project being planned for you by Coast Sign, Inc., And shall not be reproduced, used by or disclosed to any firm or corporation for any purpose whatsoever without written permission.

No.	Designer	Date	Revision Notes	No.	Designer	Date	Revision Notes
1	WA	8-14-17	refer to PATHFINDER.	7	John A.	09-29-17	refer to PATHFINDER.
2	JV	08-24-17	Added Signs C (monument sign)	8	Charles C.	12-20-17	Refer to PATHFINDER for details.
3	WA	08-30-17	refer to PATHFINDER.	9	Nariel L.	01-18-18	Refer to PATHFINDER for details.
4	WA	09-01-17	refer to PATHFINDER.	10	Rodel B.	02-07-18	Refer to PATHFINDER for details.
5	WA	09-05-17	refer to PATHFINDER.	11	John A.	02-27-18	Refer to PATHFINDER for details.
6	John A.	09-27-17	refer to PATHFINDER.	12			

DESIGN DRAWING 5 of 13
Request Number:
DEV-UBOC-00094-R12
W:\Union Bank\Art\Drawings\DEV-UBOC-00094

EXISTING PHOTO- SIGN C2



PHOTO ENHANCEMENT- SIGN C2



Date:	08-02-17	Project Name:	UNION BANK
Scale:		Address:	24532 Del Prado Ave
Drawn:	Nariel L.	City / State / Zip:	Dana Point, CA 92629
Sales:	Derrick N.	Client Approval:	Date:

This is an original unpublished drawing created by Coast Sign, Inc. It is submitted for your personal use in conjunction with a project being planned for you by Coast Sign, Inc., And shall not be reproduced, used by or disclosed to any firm or corporation for any purpose whatsoever without written permission.

No.	Designer	Date	Revision Notes	No.	Designer	Date	Revision Notes
1	WA	8-14-17	refer to PATHFINDER.	7	John A.	09-29-17	refer to PATHFINDER.
2	JV	08-24-17	Added Signs C (monument sign)	8	Charlie C.	12-20-17	Refer to PATHFINDER for details.
3	WA	08-30-17	refer to PATHFINDER.	9	Nariel L.	01-18-18	Refer to PATHFINDER for details.
4	WA	09-01-17	refer to PATHFINDER.	10	Rodel B.	02-07-18	Refer to PATHFINDER for details.
5	WA	09-05-17	refer to PATHFINDER.	11	John A.	02-27-18	Refer to PATHFINDER for details.
6	John A.	09-27-17	refer to PATHFINDER.	12			

DESIGN DRAWING 6 of 13

Request Number:
DEV-UBOC-00094-R12
 W:\Union Bank\Art\Drawings\DEV-UBOC-00094

EXISTING PHOTO- SIGN E



PHOTO ENHANCEMENT- SIGN E



BACK ENHANCED VIEW- SIGN E



**NOTE: CONCEPTUAL IMAGE ONLY
VERIFY ARTWORK AND DIMENSIONS
PRIOR TO FABRICATION**



Date:	08-02-17	Project Name:	UNION BANK
Scale:		Address:	24532 Del Prado Ave
Drawn:	Nariel L.	City / State / Zip:	Dana Point, CA 92629
Sales:	Derrick N.	Client Approval:	Date:

This is an original unpublished drawing created by Coast Sign, Inc. It is submitted for your personal use in conjunction with a project being planned for you by Coast Sign, Inc., And shall not be reproduced, used by or disclosed to any firm or corporation for any purpose whatsoever without written permission.

No.	Designer	Date	Revision Notes	No.	Designer	Date	Revision Notes
1	WA	8-14-17	refer to PATHFINDER.	7	John A.	09-29-17	refer to PATHFINDER.
2	JV	08-24-17	Added Signs C (monument sign)	8	Charle C.	12-20-17	Refer to PATHFINDER for details.
3	WA	08-30-17	refer to PATHFINDER.	9	Nariel L.	01-18-18	Refer to PATHFINDER for details.
4	WA	09-01-17	refer to PATHFINDER.	10	Rodel B.	02-07-18	Refer to PATHFINDER for details.
5	WA	09-05-17	refer to PATHFINDER.	11	John A.	02-27-18	Refer to PATHFINDER for details.
6	John A.	09-27-17	refer to PATHFINDER.	12			

DESIGN DRAWING 7 of 13
Request Number:
DEV-UBOC-00094-R12
W:\Union Bank\Art\Drawings\DEV-UBOC-00094

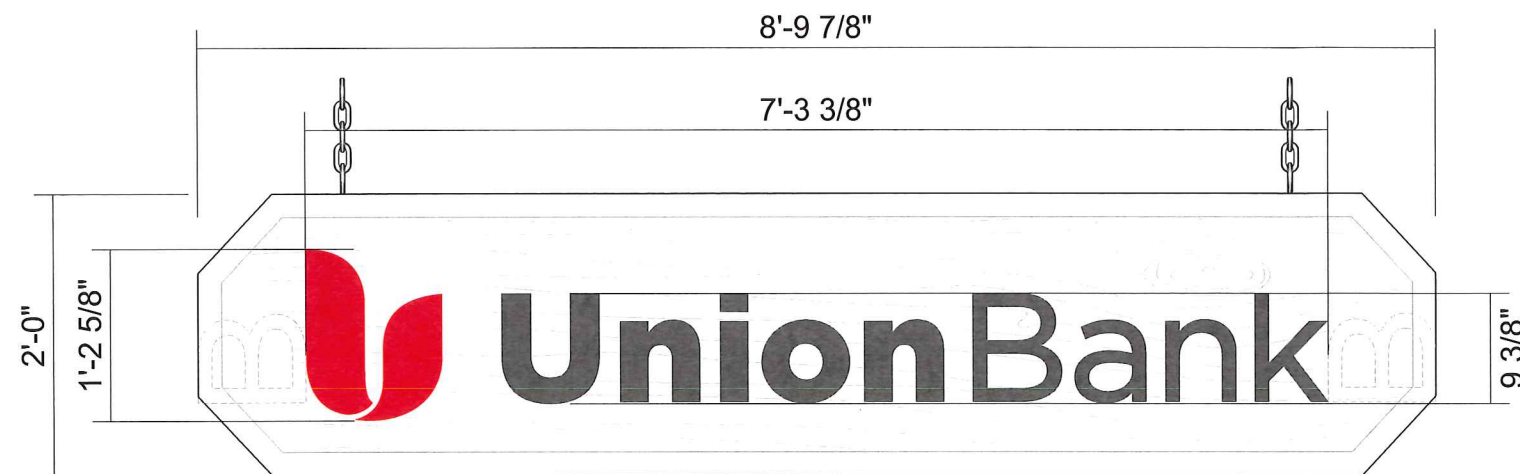

A FRONT VIEW @ S/F SAND BLASTED SIGN
Scale: 3/4" = 1'-0"

17.04 SQ FT

SIDE VIEW

SPECIFICATIONS:

SAND BLASTED WOOD PANEL PAINTED GRAPHICS
RED TULIP AND DARK GRAY UNION BANK COPY
MOUNTING: CHAIN MOUNTED

NOTE: WOOD PANEL TO BE PAINTED WHITE

COLOR LEGEND

 PANTONE: 1797
C:10 M:100 Y:100 K:0
R:230 G:0 B:0
HEX: E60000

 PANTONE COOL GRAY 11
K:80
R:90 G:90 B:90
HEX: 5A5A5A



Date: 08-02-17	Project Name: UNION BANK
Scale: AS NOTED	Address: 24532 Del Prado Ave
Drawn: Nariel L.	City / State / Zip: Dana Point, CA 92629
Sales: Derrick N.	Client Approval: _____ Date: _____

This is an original unpublished drawing created by Coast Sign, Inc. It is submitted for your personal use in conjunction with a project being planned for you by Coast Sign, Inc., And shall not be reproduced, used by or disclosed to any firm or corporation for any purpose whatsoever without written permission.

No.	Designer	Date	Revision Notes	No.	Designer	Date	Revision Notes
1	WA	8-14-17	refer to PATHFINDER.	7	John A.	09-29-17	refer to PATHFINDER.
2	JV	08-24-17	Added Signs C (monument sign)	8	Charle C.	12-20-17	Refer to PATHFINDER for details.
3	WA	08-30-17	refer to PATHFINDER.	9	Nariel L.	01-18-18	Refer to PATHFINDER for details.
4	WA	09-01-17	refer to PATHFINDER.	10	Rodel B.	02-07-18	Refer to PATHFINDER for details.
5	WA	09-05-17	refer to PATHFINDER.	11	John A.	02-27-18	Refer to PATHFINDER for details.
6	John A.	09-27-17	refer to PATHFINDER.	12			

DESIGN DRAWING 8 of 13
Request Number:
DEV-UBOC-00094-R12
W:\Union Bank\Art\Drawings\DEV-UBOC-00094

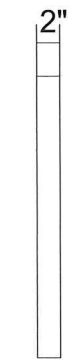
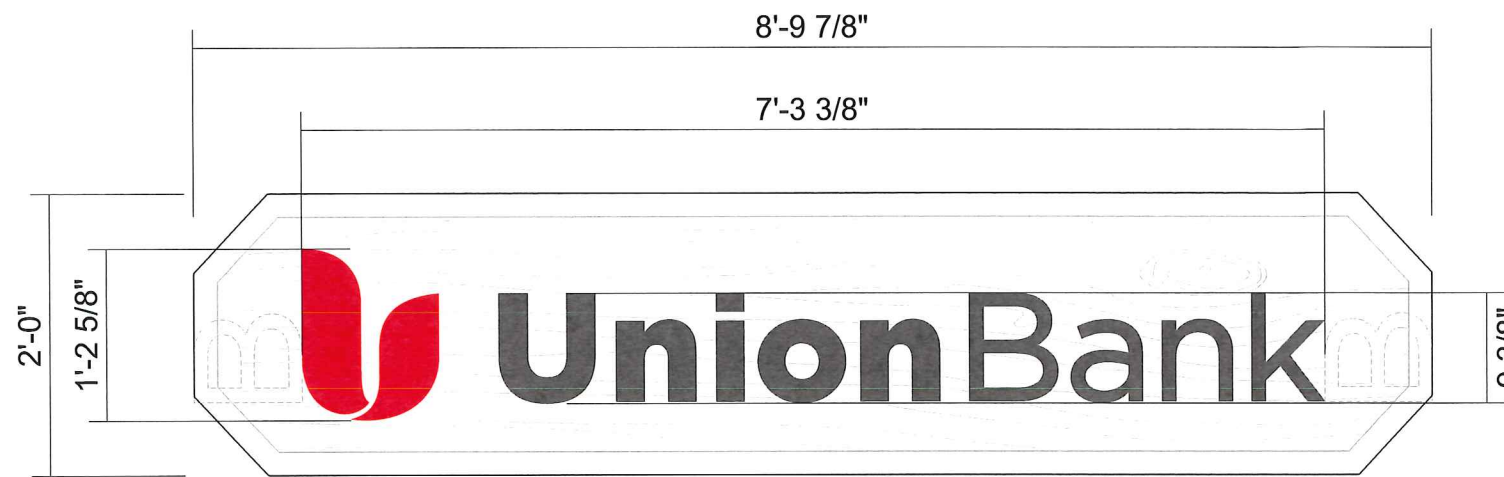



B FRONT VIEW @ S/F SAND BLASTED SIGN
Scale: 3/4" = 1'-0"

SIDE VIEW

17.04 SQ FT

SPECIFICATIONS:
SAND BLASTED WOOD PANEL PAINTED GRAPHICS
RED TULIP AND DARK GRAY UNION BANK COPY
MOUNTING:

NOTE: WOOD PANEL TO BE PAINTED WHITE

COLOR LEGEND	
	PANTONE: 1797 C:10 M:100 Y:100 K:0 R:230 G:0 B:0 HEX: E60000
	PANTONE COOL GRAY 11 K:80 R:90 G:90 B:90 HEX: 5A5A5A



Date: 08-02-17	Project Name: UNION BANK
Scale: AS NOTED	Address: 24532 Del Prado Ave
Drawn: Nariel L.	City / State / Zip: Dana Point, CA 92629
Sales: Derrick N.	Client Approval: _____ Date: _____

This is an original unpublished drawing created by Coast Sign, Inc. It is submitted for your personal use in conjunction with a project being planned for you by Coast Sign, Inc., And shall not be reproduced, used by or disclosed to any firm or corporation for any purpose whatsoever without written permission.

No.	Designer	Date	Revision Notes	No.	Designer	Date	Revision Notes
1	WA	8-14-17	refer to PATHFINDER.	7	John A.	09-29-17	refer to PATHFINDER.
2	JV	08-24-17	Added Signs C (monument sign)	8	Charle C.	12-20-17	Refer to PATHFINDER for details.
3	WA	08-30-17	refer to PATHFINDER.	9	Nariel L.	01-18-18	Refer to PATHFINDER for details.
4	WA	09-01-17	refer to PATHFINDER.	10	Rodel B.	02-07-18	Refer to PATHFINDER for details.
5	WA	09-05-17	refer to PATHFINDER.	11	John A.	02-27-18	Refer to PATHFINDER for details.
6	John A.	09-27-17	refer to PATHFINDER.	12			

DESIGN DRAWING 9 of 13
Request Number:
DEV-UBOC-00094-R12
W:\Union Bank\Art\Drawings\DEV-UBOC-00094



FRONT VIEW @ S/F HANGING SAND BLASTED SIGN

Scale: 1 1/2" = 1'-0"

6.48 SQ FT

SIDE VIEW

SPECIFICATIONS:
 SAND BLASTED WOOD PANEL PAINTED GRAPHICS
 RED TULIP AND DARK GRAY UNION BANK COPY
 MOUNTING: CHAIN MOUNTED

NOTE: WOOD PANEL TO BE PAINTED WHITE

COLOR LEGEND

 PANTONE: 1797
 C:10 M:100 Y:100 K:0
 R:230 G:0 B:0
 HEX: E60000

 PANTONE COOL GRAY 11
 K:80
 R:90 G:90 B:90
 HEX: 5A5A5A



Date: 08-02-17	Project Name: UNION BANK
Scale:	Address: 24532 Del Prado Ave
Drawn: Nariel L.	City / State / Zip: Dana Point, CA 92629
Sales: Derrick N.	Client Approval: _____ Date: _____

This is an original unpublished drawing created by Coast Sign, Inc. It is submitted for your personal use in conjunction with a project being planned for you by Coast Sign, Inc., And shall not be reproduced, used by or disclosed to any firm or corporation for any purpose whatsoever without written permission.

No.	Designer	Date	Revision Notes	No.	Designer	Date	Revision Notes
1	WA	8-14-17	refer to PATHFINDER.	7	John A.	09-29-17	refer to PATHFINDER.
2	JV	08-24-17	Added Signs C (monument sign)	8	Charlie C.	12-20-17	Refer to PATHFINDER for details.
3	WA	08-30-17	refer to PATHFINDER.	9	Nariel L.	01-18-18	Refer to PATHFINDER for details.
4	WA	09-01-17	refer to PATHFINDER.	10	Rodel B.	02-07-18	Refer to PATHFINDER for details.
5	WA	09-05-17	refer to PATHFINDER.	11	John A.	02-27-18	Refer to PATHFINDER for details.
6	John A.	09-27-17	refer to PATHFINDER.	12			

DESIGN DRAWING 10 of 13
 Request Number:
DEV-UBOC-00094-R12
 W:\Union Bank\Art\Drawings\DEV-UBOC-00094

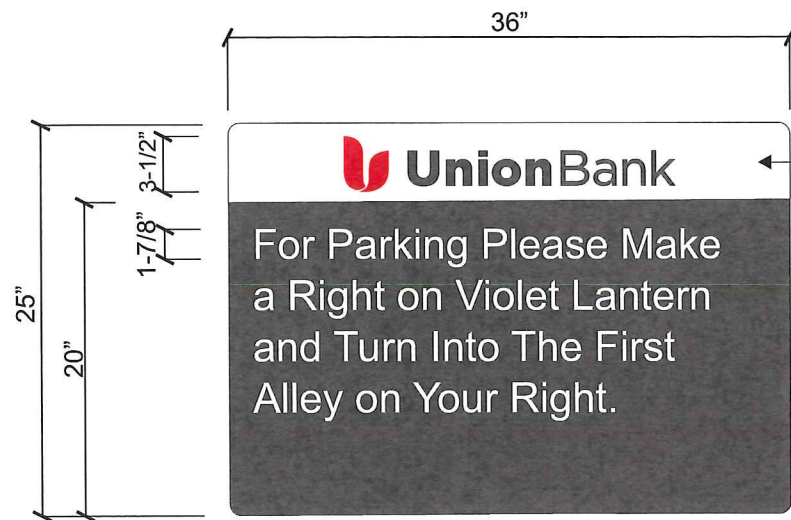

PAINTED .090 ALUMINUM PANEL WITH NO VISIBLE FASTENERS PAINT TO MATCH MP03673,SATIN FINISH

D FRONT VIEW @ WALL MOUNTED PLAQUE
Scale: 1" = 1'-0" **6.25 SQ FT**

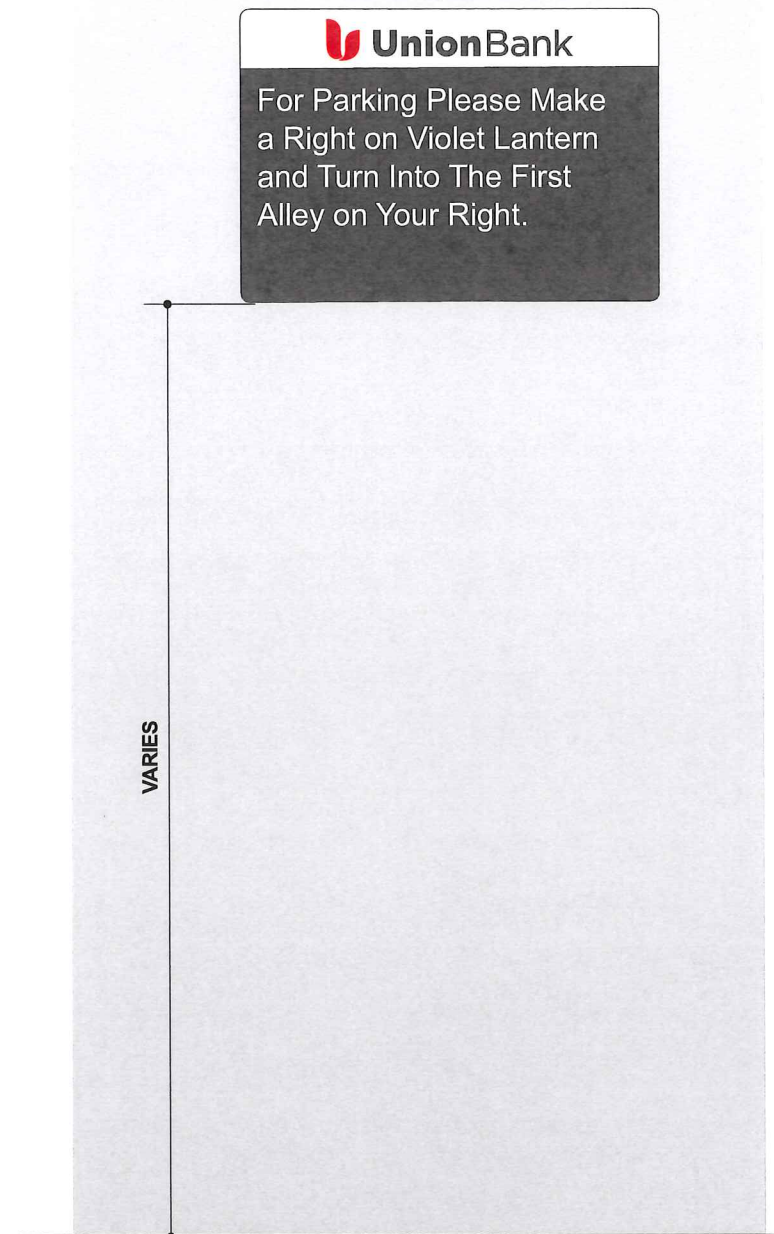

* Mounting height may vary based on site conditions.

Wall Mounted Vehicular and Pedestrian Directional

Pole mounted directional signs. Use these signs to direct customers through a Union Bank complex, or to amenities within the complex such as a Drive-up ATM or Customer Parking.

Materials List

- ① Logo applied vinyl, red.
- ② Painted aluminum panel, no visible fasteners.
- ③ Painted pantone cool gray 11, with applied white vinyl graphics
- ④ Mount to wall with tape/silicone/studs

COLOR LEGEND

 PANTONE: 1797
C:10 M:100 Y:100 K:0
R:230 G:0 B:0
HEX: E60000

 PANTONE COOL GRAY 11
K:80
R:90 G:90 B:90
HEX: 5A5A5A



Date:	08-02-17	Project Name:	UNION BANK
Scale:		Address:	24532 Del Prado Ave
Drawn:	Nariel L.	City / State / Zip:	Dana Point, CA 92629
Sales:	Derrick N.	Client Approval:	Date:

This is an original unpublished drawing created by Coast Sign, Inc. It is submitted for your personal use in conjunction with a project being planned for you by Coast Sign, Inc., And shall not be reproduced, used by or disclosed to any firm or corporation for any purpose whatsoever without written permission.

No.	Designer	Date	Revision Notes	No.	Designer	Date	Revision Notes
1	WA	8-14-17	refer to PATHFINDER.	7	John A.	09-29-17	refer to PATHFINDER.
2	JV	08-24-17	Added Signs C (monument sign)	8	Charles C.	12-20-17	Refer to PATHFINDER for details.
3	WA	08-30-17	refer to PATHFINDER.	9	Nariel L.	01-18-18	Refer to PATHFINDER for details.
4	WA	09-01-17	refer to PATHFINDER.	10	Rodel B.	02-07-18	Refer to PATHFINDER for details.
5	WA	09-05-17	refer to PATHFINDER.	11	John A.	02-27-18	Refer to PATHFINDER for details.
6	John A.	09-27-17	refer to PATHFINDER.	12			

DESIGN DRAWING 11 of 13
Request Number: DEV-UBOC-00094-R12
W:\Union Bank\Art\Drawings\DEV-UBOC-00094

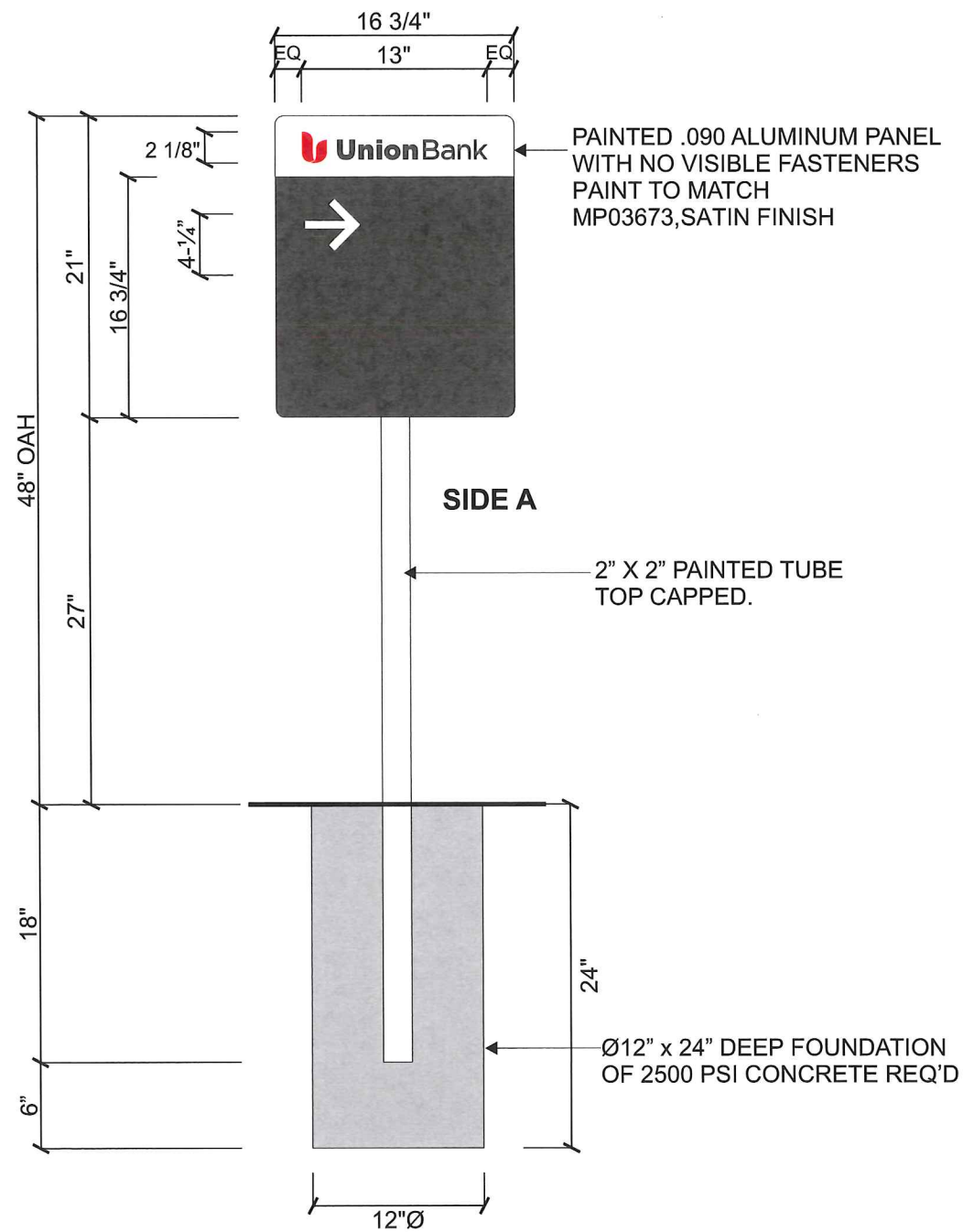

PAINTED .090 ALUMINUM PANEL WITH NO VISIBLE FASTENERS
PAINT TO MATCH MP03673, SATIN FINISH

SIDE A

2" X 2" PAINTED TUBE TOP CAPPED.

Ø12" x 24" DEEP FOUNDATION OF 2500 PSI CONCRETE REQ'D

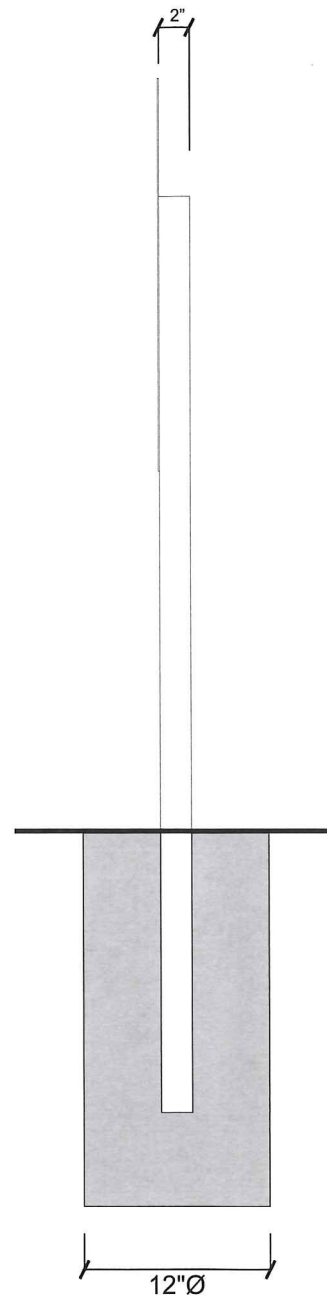

SIDE VIEW

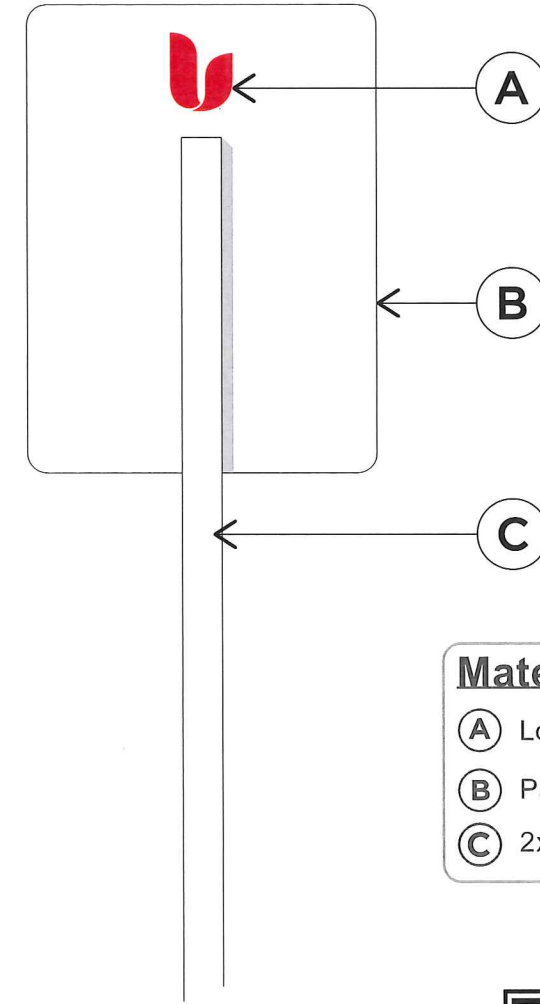

- Materials List**
- (A) Logo symbol applied vinyl
 - (B) Painted aluminum panel, no visible fasteners
 - (C) 2x2 painted tube, top capped, no seams

NOTE: EXACT FOOTING SIZE / DETAILS TO BE DETERMINED IN STRUCTURAL ENGINEERING

COLOR LEGEND	
	PANTONE: 1797 C:10 M:100 Y:100 K:0 R:230 G:0 B:0 HEX: E60000
	PANTONE COOL GRAY 11 K:80 R:90 G:90 B:90 HEX: 5A5A5A

E FRONT VIEW @ DIRECTIONAL POLE SIGN
Scale: 1" = 1'-0" **2.44 SQ FT**



Date: 08-02-17	Project Name: UNION BANK
Scale:	Address: 24532 Del Prado Ave
Drawn: Nariel L.	City / State / Zip: Dana Point, CA 92629
Sales: Derrick N.	Client Approval: _____ Date: _____

This is an original unpublished drawing created by Coast Sign, Inc. It is submitted for your personal use in conjunction with a project being planned for you by Coast Sign, Inc., And shall not be reproduced, used by or disclosed to any firm or corporation for any purpose whatsoever without written permission.

No.	Designer	Date	Revision Notes	No.	Designer	Date	Revision Notes
1	WA	8-14-17	refer to PATHFINDER.	7	John A.	09-29-17	refer to PATHFINDER.
2	JV	08-24-17	Added Signs C (monument sign)	8	Charle C.	12-20-17	Refer to PATHFINDER for details.
3	WA	08-30-17	refer to PATHFINDER.	9	Nariel L.	01-18-18	Refer to PATHFINDER for details.
4	WA	09-01-17	refer to PATHFINDER.	10	Rodel B.	02-07-18	Refer to PATHFINDER for details.
5	WA	09-05-17	refer to PATHFINDER.	11	John A.	02-27-18	Refer to PATHFINDER for details.
6	John A.	09-27-17	refer to PATHFINDER.	12			

DESIGN DRAWING 12 of 13
Request Number:
DEV-UBOC-00094-R12
W:\Union Bank\Art\Drawings\DEV-UBOC-00094